

52" Ceiling Fan

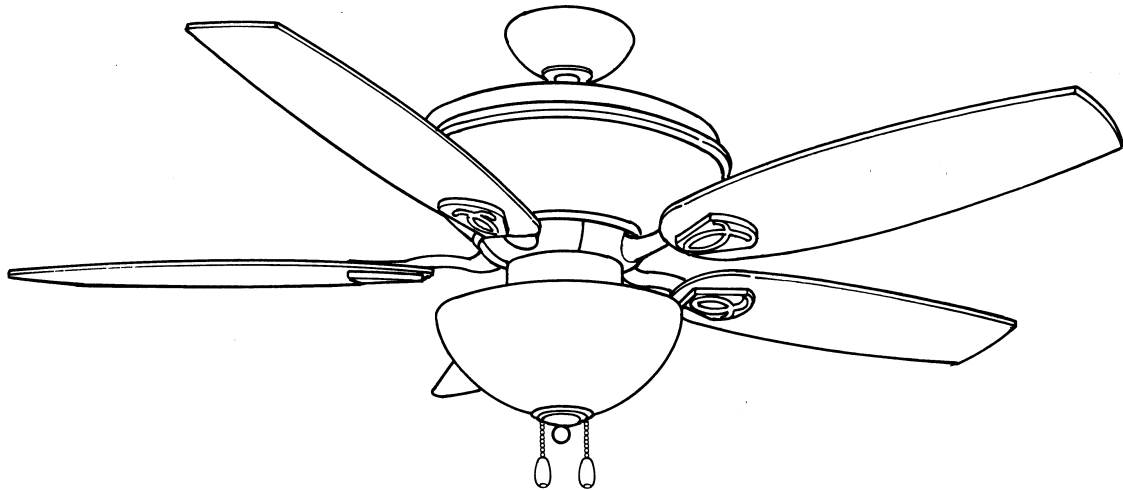

CORSICA FAN
MODEL CF-31430



To Begin

Weight: 27.01Lbs

Check to make sure you have the following:

Required

Helpful

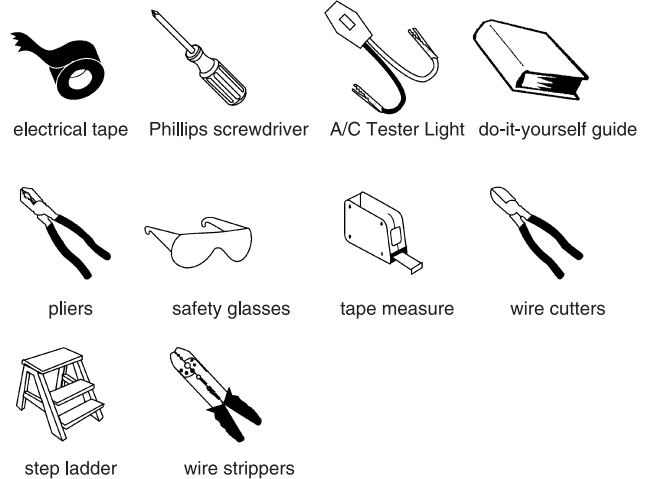
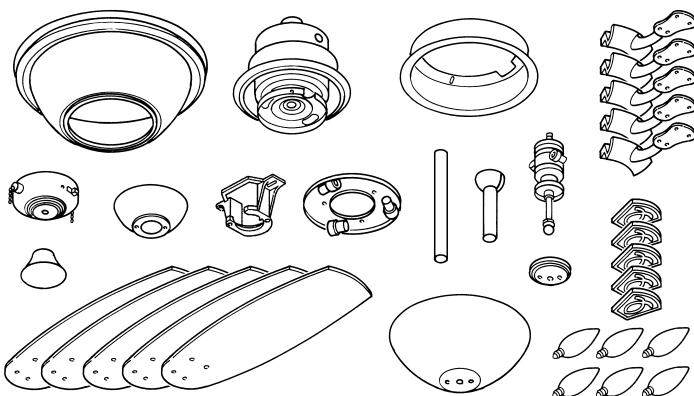

Preparation

⚠ Important: When using an existing outlet box be sure the box is securely attached to the building structure and can support the full weight of the fan.
Failure to do so can result in serious injury or death.

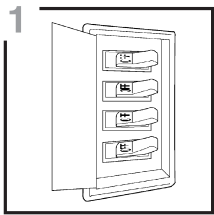
1  Turn off circuit breakers and wall switch to the fan supply line leads.

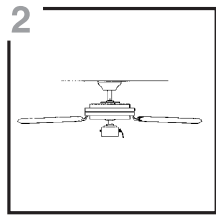
2  Downrod Mounting

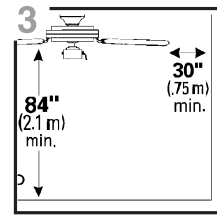
3  Check to make sure blades are at least 30 inches from any obstruction. Check downrod length to ensure blades are at least 84" (7 feet) above the floor.

⚠ Warning: Failure to disconnect power supply prior to installation may result in serious injury or death.

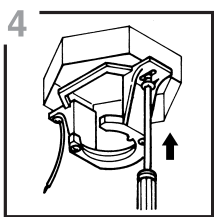
4  Secure mounting bracket to electrical box.
Important: If using the angle mount, make sure open end of mounting bracket is installed facing the roof.

Ⓐ Downrod Fan Mounting

Helpful Hint: Downrod style mounting is best suited for ceilings 8 feet high or higher. For taller ceilings you may want to use an extension rod (not included).
Angle style mounting is best suited for angled or vaulted ceilings. A longer extension rod will be needed to ensure proper blade clearance.

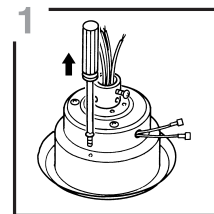
1  Remove all the screws on the bottom level of the motor.

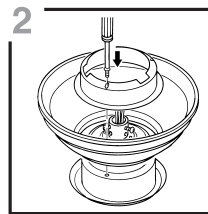
2  Install the top glass and motor cover on the motor. Tighten all the screws to secure the cover.

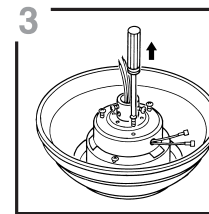
3  Loosen all the screws on the upper level of the motor but remove only one.

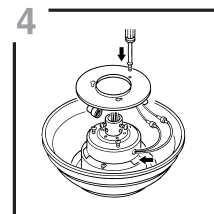
4  Put on the light pan and connect wires. Tighten the light pan on the motor and secure it with screws.

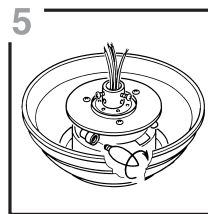
5  Install three C26 40 Watt bulbs (included) to the sockets.

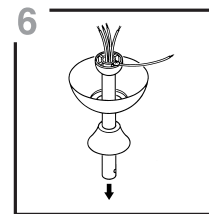
6  Insert the downrod through canopy and cover of collar with the ball toward the ceiling. Feed wires from the fan motor through the downrod.

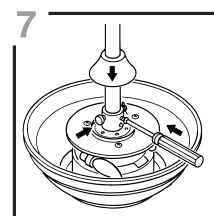
7  Slip the downrod over the wire sleeve, align the hole and reinstall the pin and clip. Firmly tighten both downrod set screws.

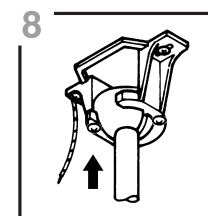
8  Hang the fan in the mounting bracket. Align the slot in the ball with the tab on the bracket.

Wiring

⚠ Important: Make sure wiring box is properly grounded or that a ground(green) wire is present.

Note: Black wire is hot power for fan. Blue wire is hot power for light kit. White wire is common for fan and light kit as neutral wires. Green wire is ground.

⚠ Warning: If house wires are different colors than referred to above. Stop immediately. A professional electrician is recommended to determine wiring.

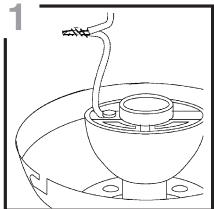

1 Connect green wire from downrod to green wire on mounting bracket.

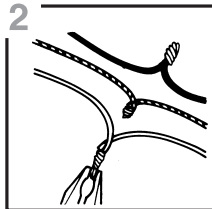

2 Strip 3/4 inches of insulation from wire ends. Twist stripped ends together with pliers:white to white; black to black and blue to blue (or black and blue to black);and green to green (ground).Snip ends.

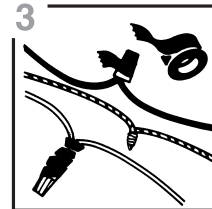

3 Screw on wire nuts in a clockwise direction. Tape nuts and wires together.

⚠ Warning: Be sure no bare wire or wire strands are visible after making connection. Place green and white connections on opposite side of box from the black and blue (if applicable) connections.

Final Installation

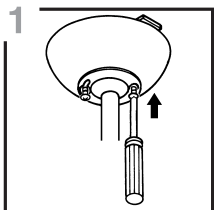

1 Lift canopy to hanger bracket. Tighten all screws securely.

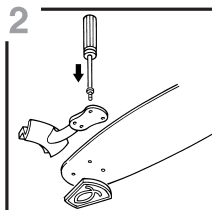

2 Position blade bracket so that it rests flush against blade. Tighten all screws securely.

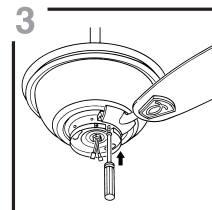

3 Insert only one screw through blade bracket and partially tighten. Insert 2nd screw tighten and then tighten 1st screw. Repeat with remaining blades.

⚠ Warning: For downrod mounting be sure that the tab in the bracket rests in the slot of the ball end.

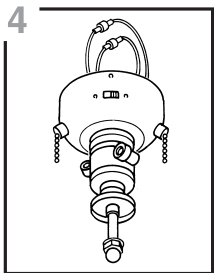

4 Remove the knob from switch housing. Screw the light kit into the switch housing.

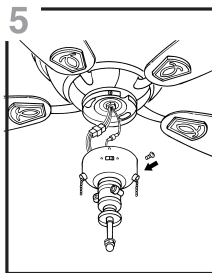

5 Install the light kit into the fan.

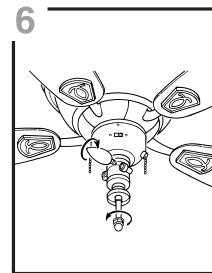

6 Install three C26 40 watt bulbs (included). Remove the washer, nut, and finial from the lightkit.

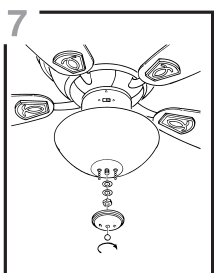

7 Install the bottom glass and secure it by washer, nut, cap, and finial.

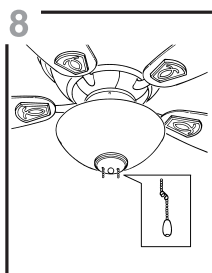

8 Clip on the pull chains.

Replacement Parts

Keep this guide handy for ordering replacement parts.

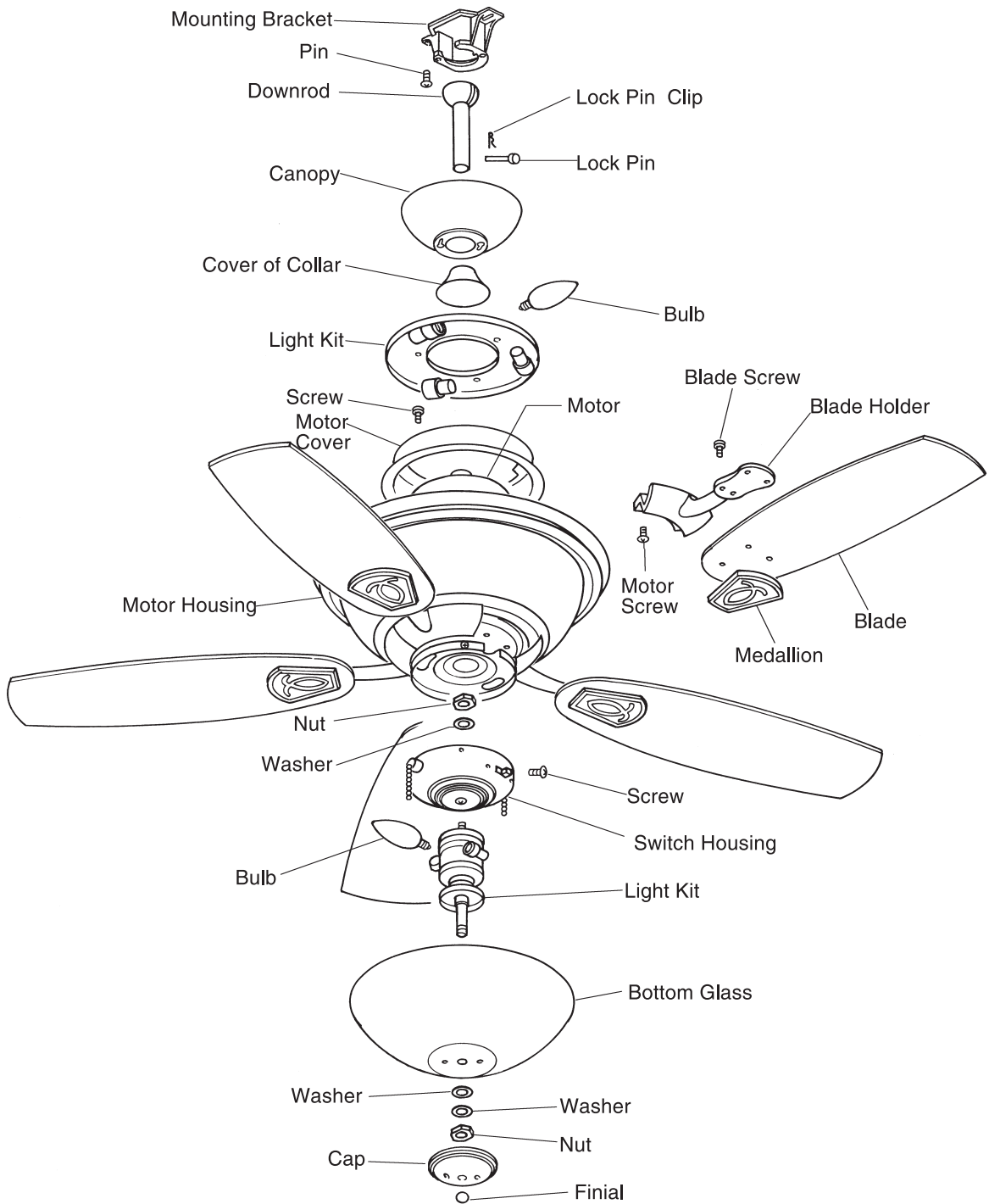

Triarch International, Inc.